



Templates

Issue 45

PRINT AT 100% SIZE

When printed at the correct size, this box will measure 1in / 26mm square

CORNFLOWER HUES

by Victoria Carrington page 77

TEMPLATES



ACTUAL SIZE

Includes seam allowances

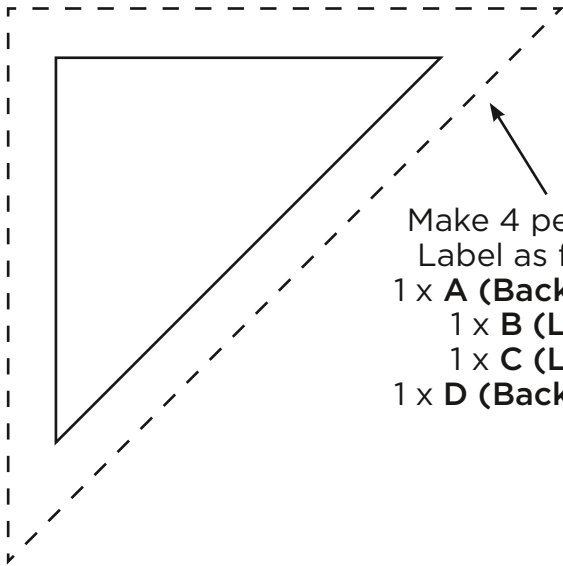

Make 4 per block.
Label as follows:
1 x **A (Background)**
1 x **B (Light)**
1 x **C (Light)**
1 x **D (Background)**

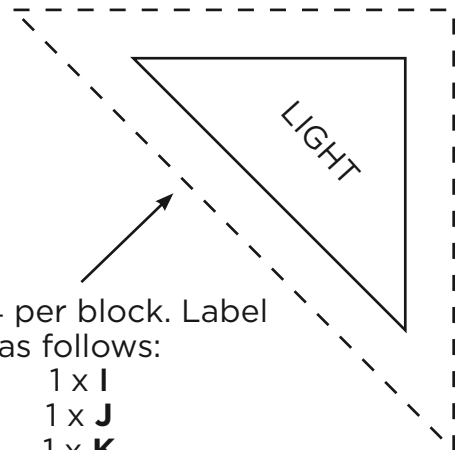

Make 4 per block. Label as follows:
1 x **I**
1 x **J**
1 x **K**
1 x **L**

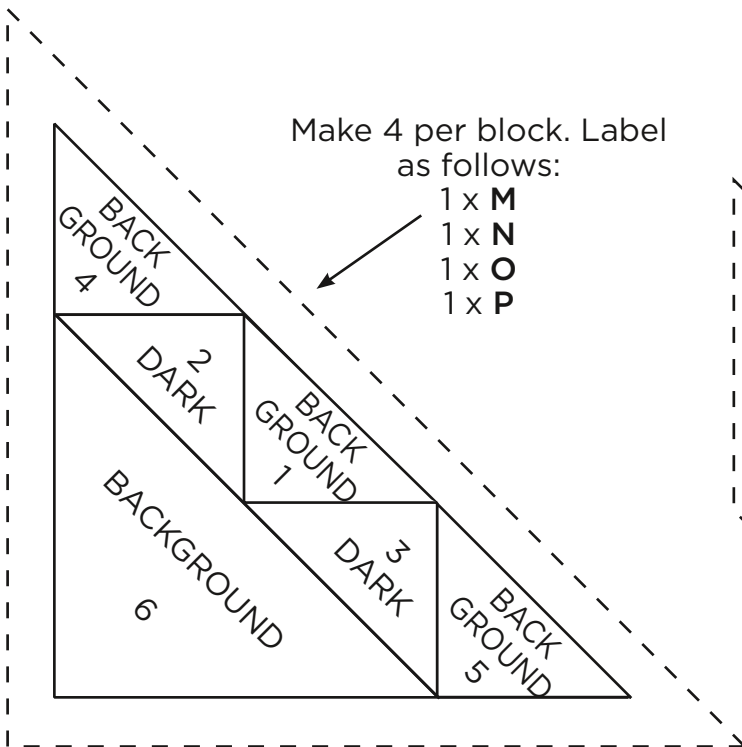

Make 4 per block. Label as follows:
1 x **M**
1 x **N**
1 x **O**
1 x **P**

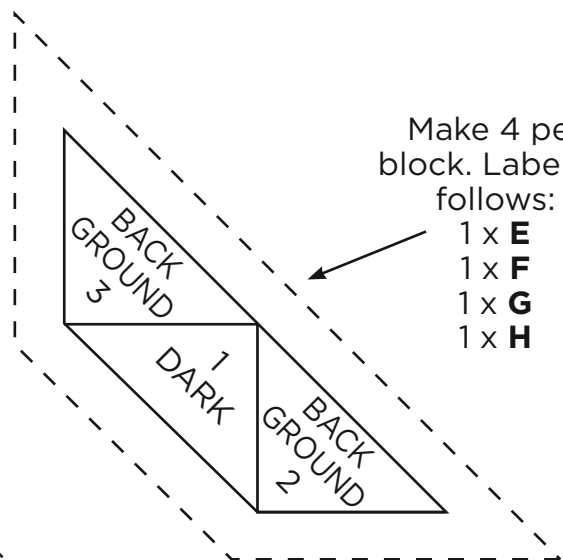

Make 4 per block. Label as follows:
1 x **E**
1 x **F**
1 x **G**
1 x **H**

When printed at the correct size, this box will measure 1in / 26mm square

BLOCK OF THE MONTH

by Carolyn Forster page 85

HAND-PIECING TEMPLATES

ACTUAL SIZE

PLEASE NOTE: Hand-piecing templates do NOT include seam allowances

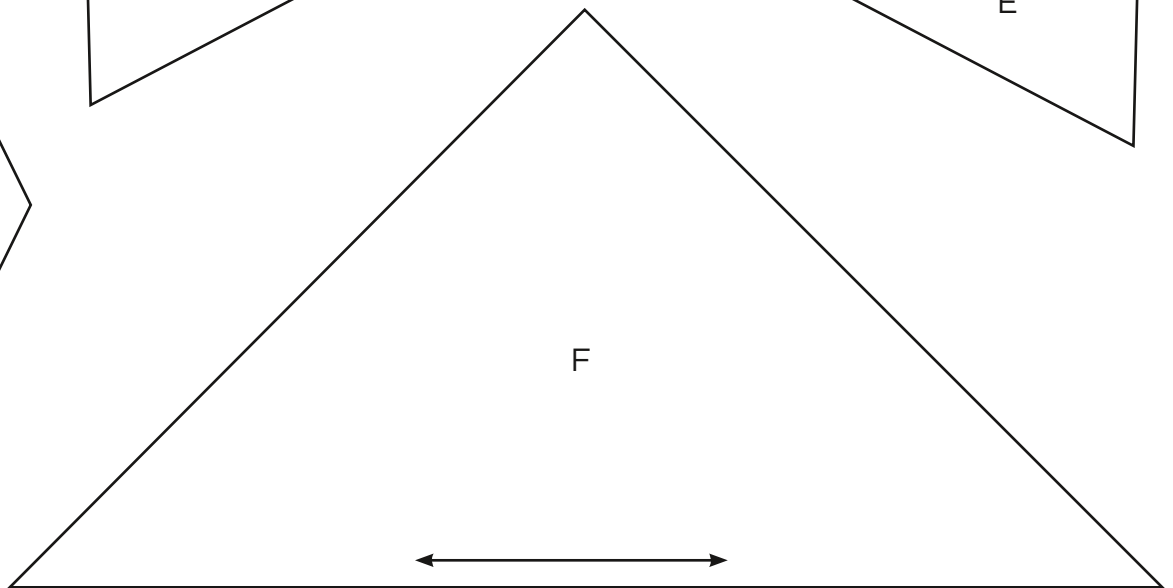
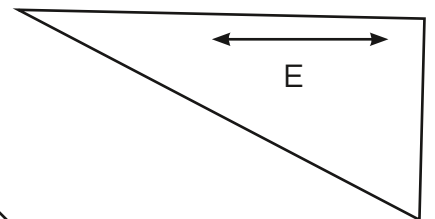
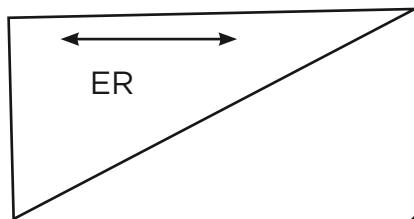
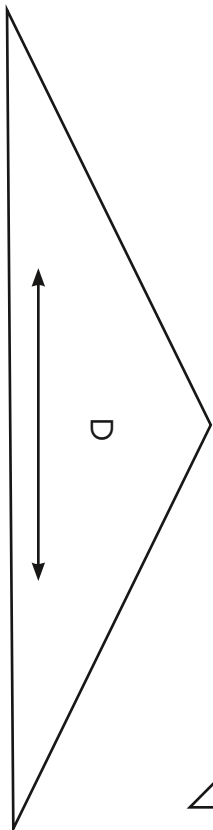
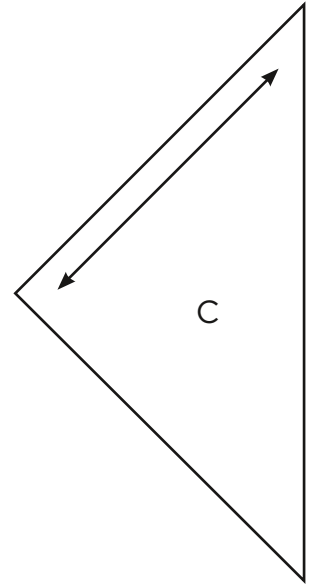
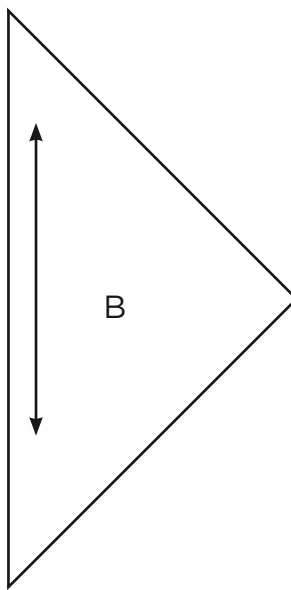
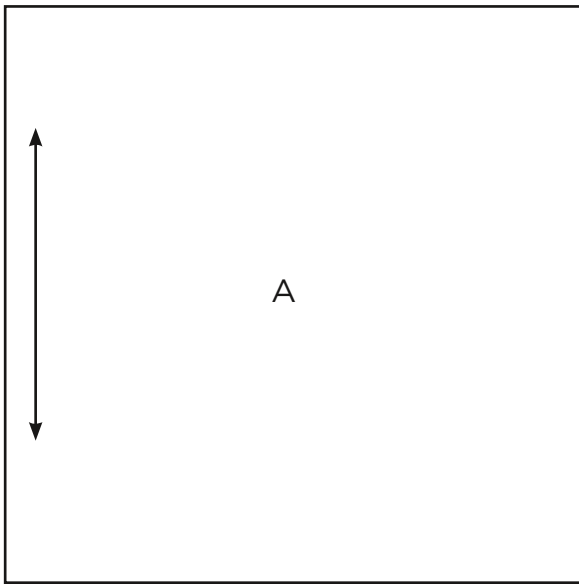

When printed
at the correct
size, this box
will measure
1in / 26mm
square

WOVEN WINDMILLS

by Carolyn Forster page 48

TEMPLATES A & B

ACTUAL SIZE
Includes seam allowances

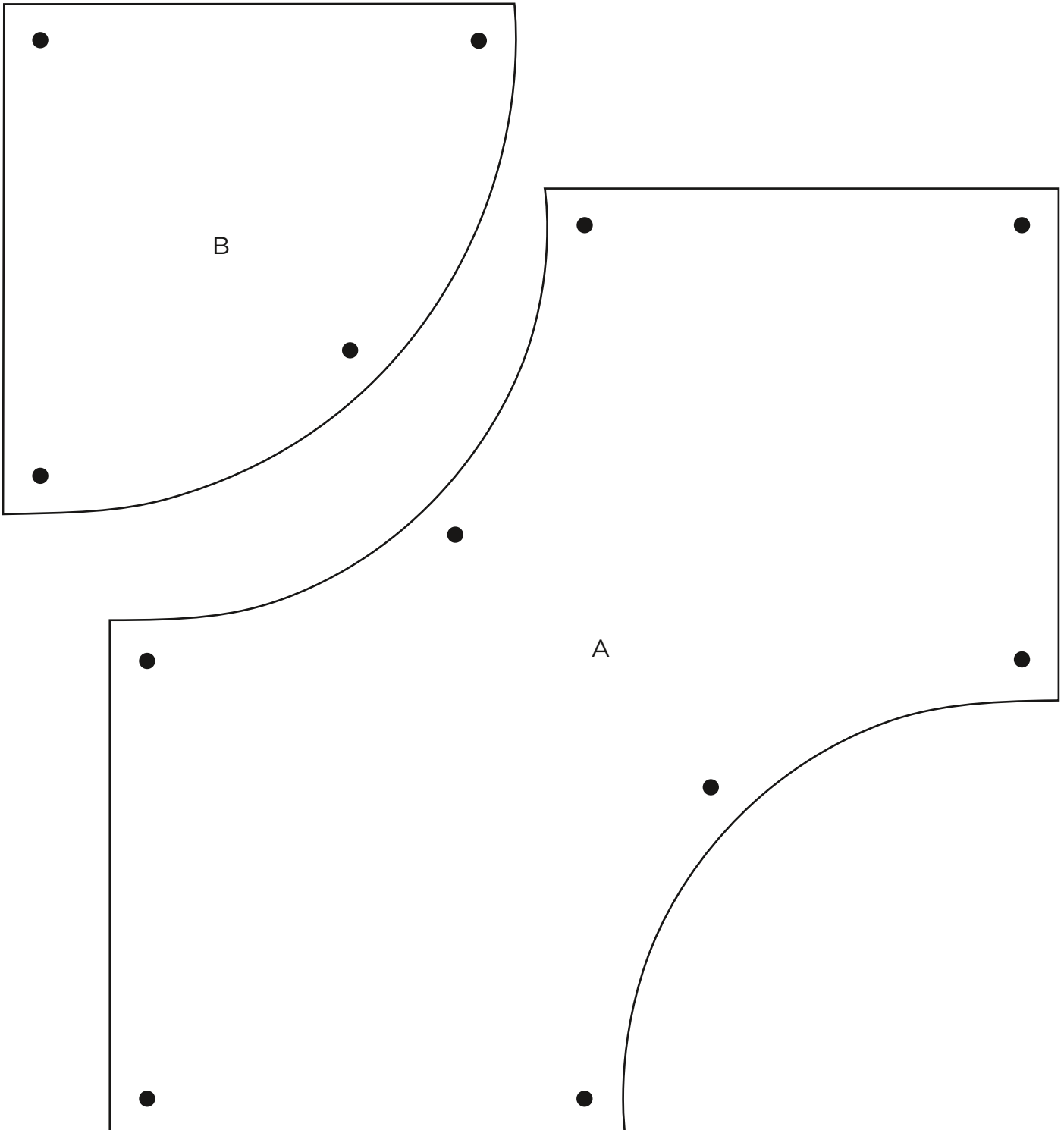

When printed
at the correct
size, this box
will measure
1in / 26mm
square

SAY IT WITH FLOWERS

by Irene Blanck page 34

APPLIQUÉ PATTERN (PART 1)

ACTUAL SIZE

PLEASE NOTE: Appliqué templates do
NOT include seam allowances

Join Part 1 to Part 2

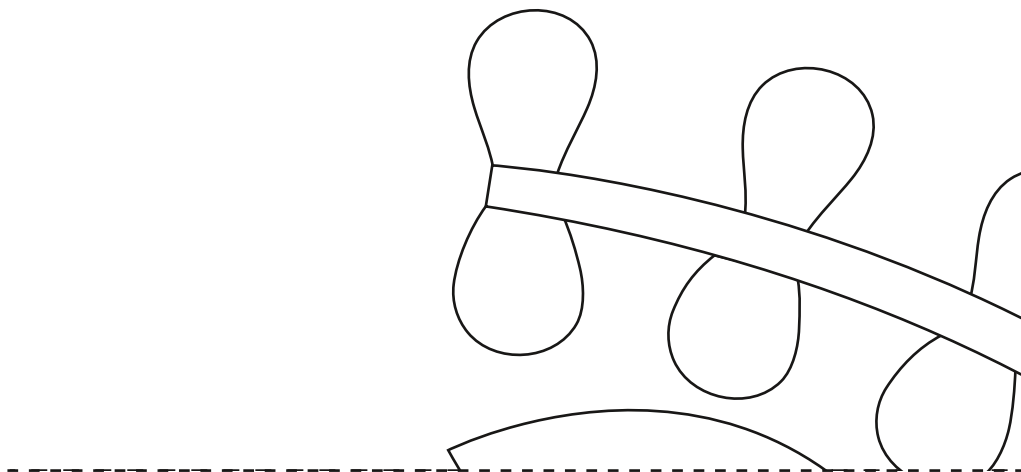

Join Part 1 to Part 4

When printed at the correct size, this box will measure 1in / 26mm square

SAY IT WITH FLOWERS

by Irene Blanck page 34

APPLIQUÉ PATTERN (PART 2)

ACTUAL SIZE

PLEASE NOTE: Appliqué templates do NOT include seam allowances

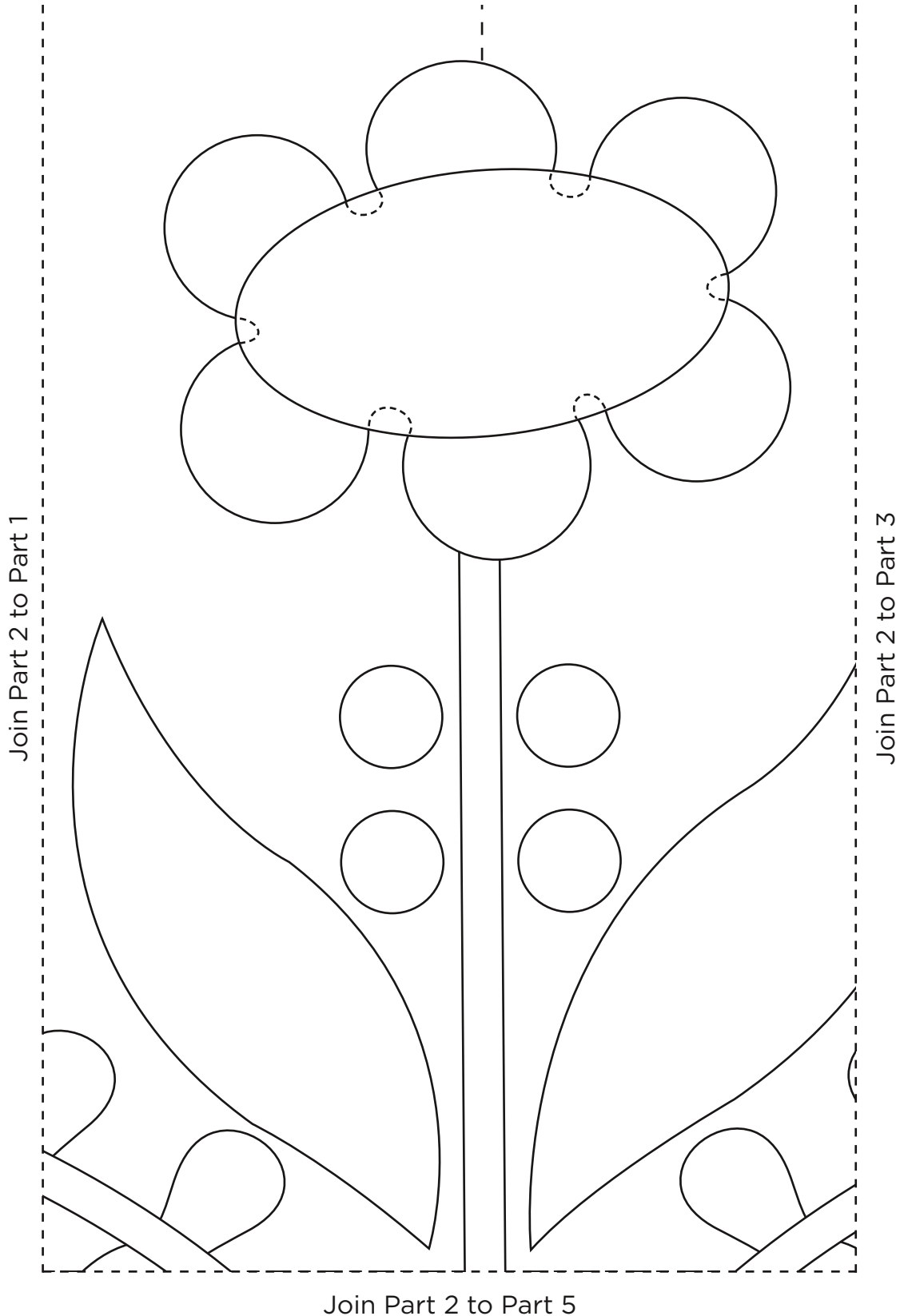

When printed
at the correct
size, this box
will measure
1in / 26mm
square

SAY IT WITH FLOWERS

by Irene Blanck page 34

APPLIQUÉ PATTERN (PART 3)

ACTUAL SIZE

PLEASE NOTE: Appliqué templates do
NOT include seam allowances

Join Part 3 to Part 2

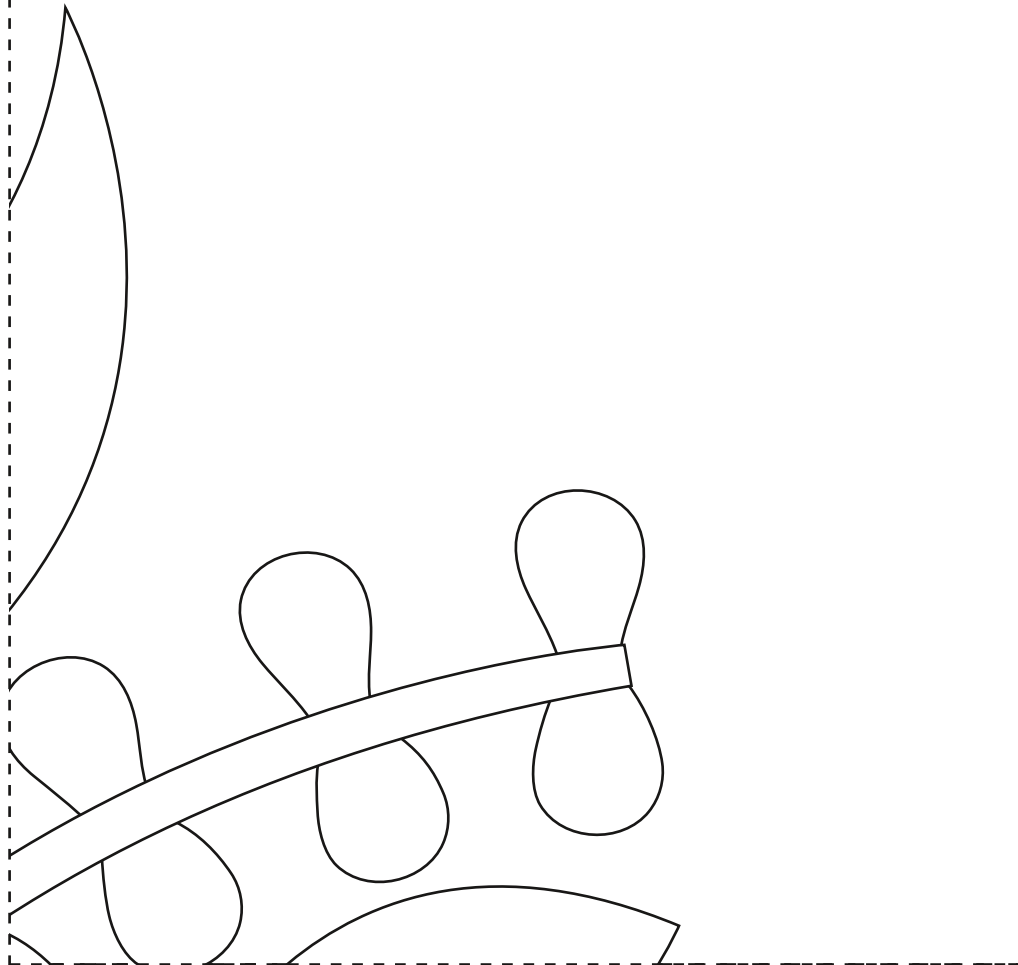

Join Part 3 to Part 6

When printed
at the correct
size, this box
will measure
1in / 26mm
square

SAY IT WITH FLOWERS

by Irene Blanck page 34

Join Part 4 to Part 1

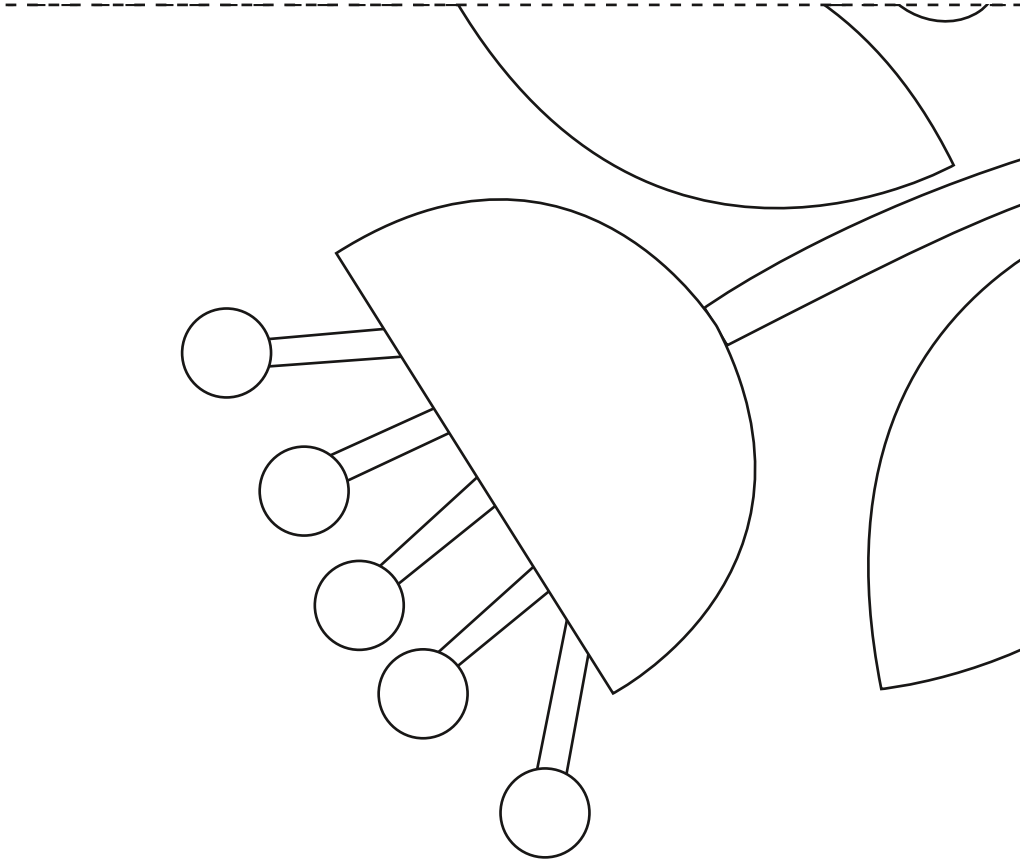

Join Part 4 to Part 5

APPLIQUÉ PATTERN (PART 4)

— —

ACTUAL SIZE

PLEASE NOTE: Appliqué templates do
NOT include seam allowances

When printed at the correct size, this box will measure 1in / 26mm square

SAY IT WITH FLOWERS

by Irene Blanck page 34

APPLIQUÉ PATTERN (PART 5)

ACTUAL SIZE

PLEASE NOTE: Appliqué templates do NOT include seam allowances

Join Part 5 to Part 2

Join Part 5 to Part 4

Join Part 5 to Part 6

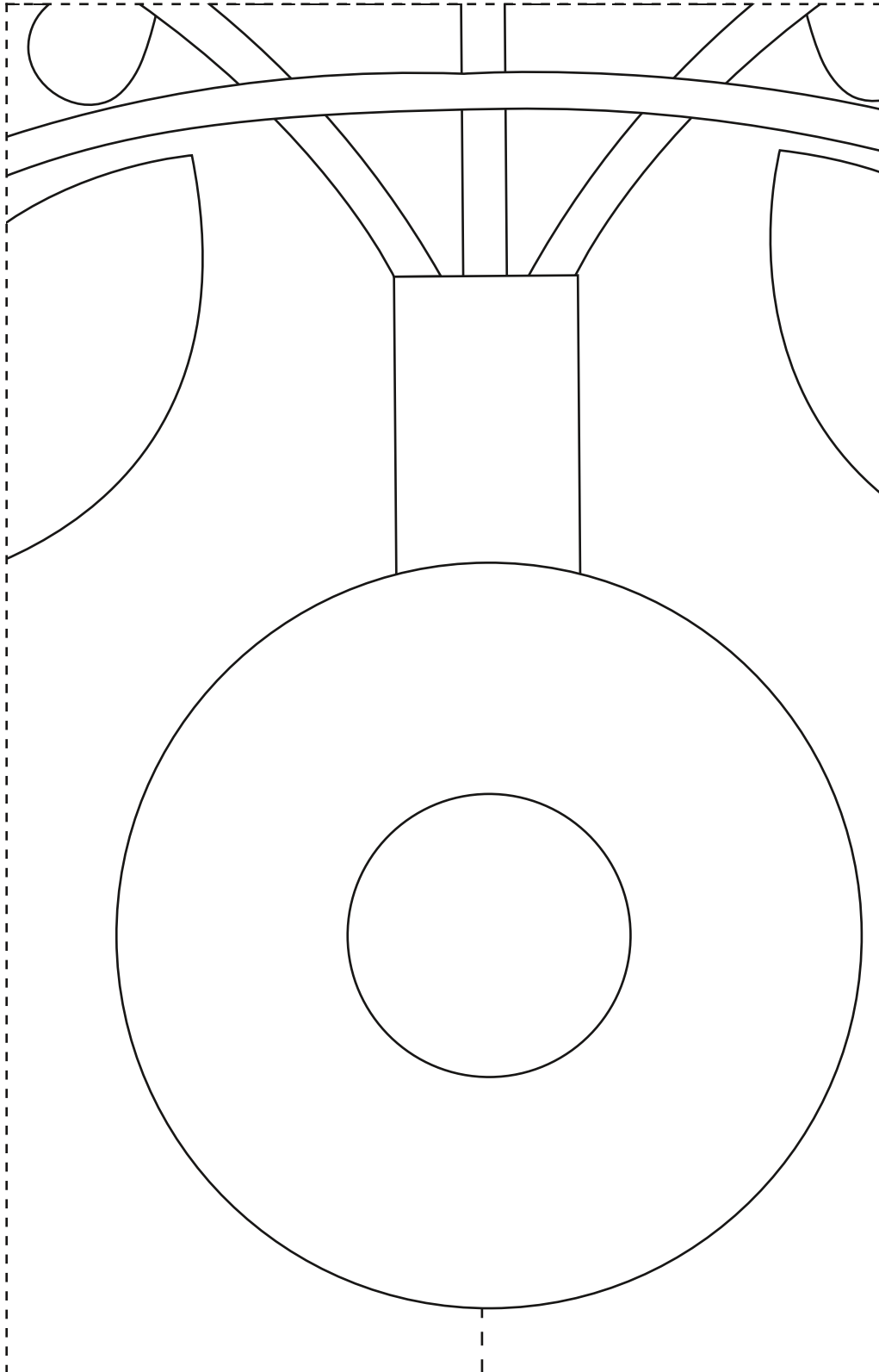

When printed
at the correct
size, this box
will measure
1in / 26mm
square

SAY IT WITH FLOWERS

by Irene Blanck page 34

Join Part 6 to Part 3

Join Part 6 to Part 5

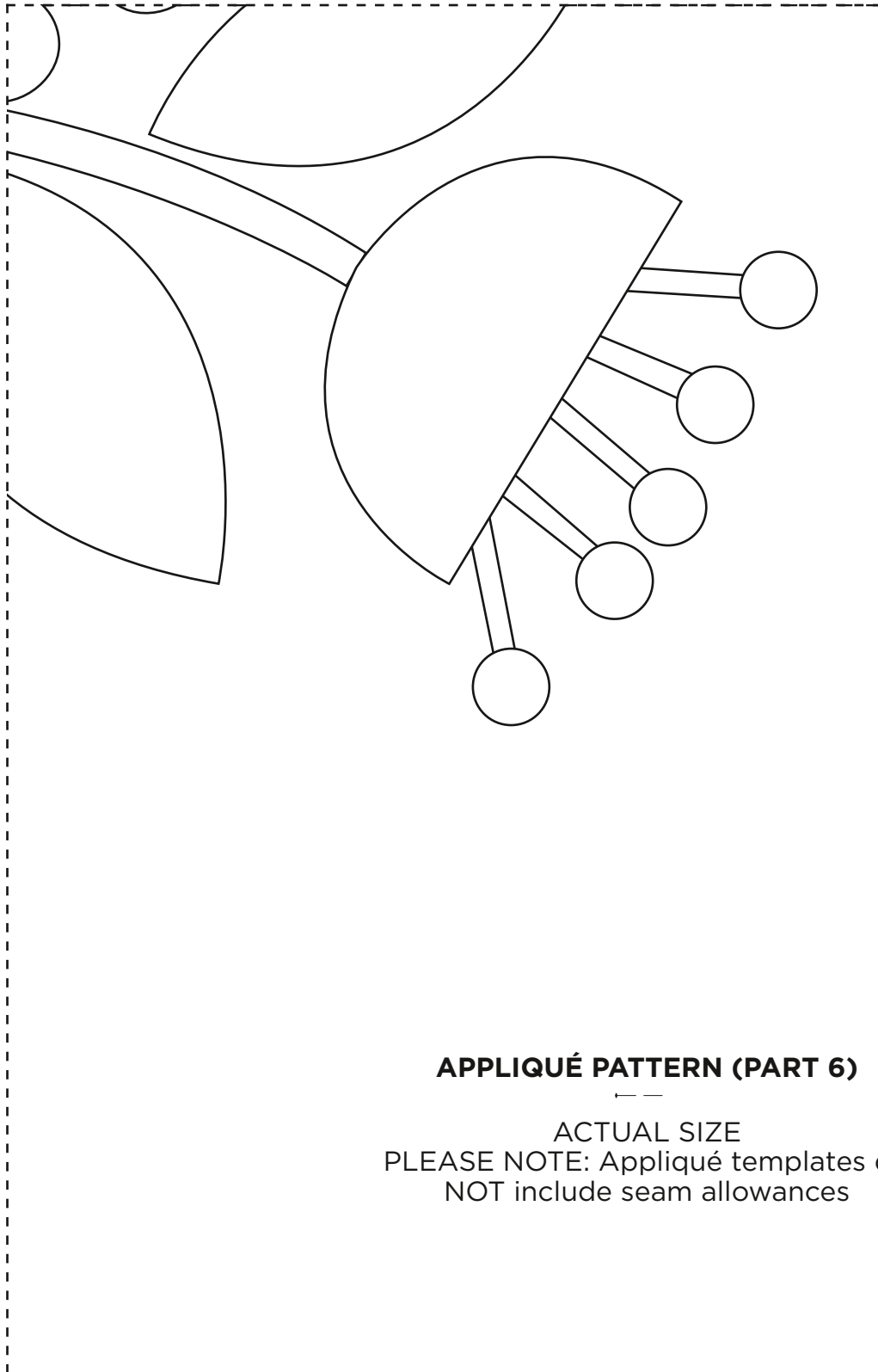

APPLIQUÉ PATTERN (PART 6)

ACTUAL SIZE

PLEASE NOTE: Appliqué templates do
NOT include seam allowances